

Sheet: console

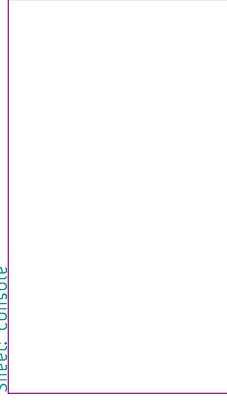

File: console.sch

Sheet: cpu



File: cpu.sch

Sheet: ide



File: ide.sch

Sheet: iot



File: iot.sch

Sheet: memory

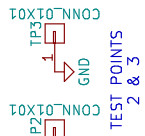
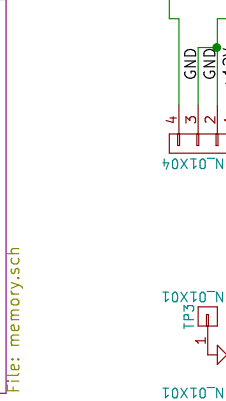

TEST POINTS
2 & 3

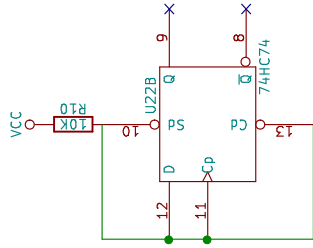
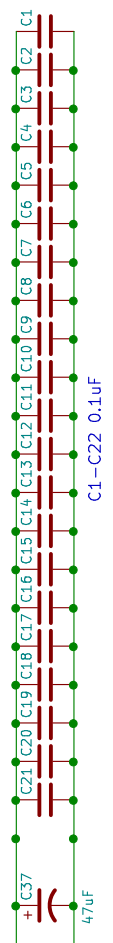
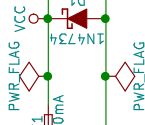

3.2MM MOUNTING HOLES

SPARETIMEGIZMOS
SPARE TIME GIZMOS LOGO
LOGO1

RBC EDITION V1.00 SCHEMATIC CHANGES FROM ORIGINAL STG SCHEMATIC:

1. RELOCATED POWER INPUT/DECOUPLING CAPS TO TOP LEVEL SHEET.
2. RELOCATED TP2/TP3 TO TOP LEVEL SHEET.
3. RELOCATED SPARE/JUNUSED 74HC74 TO TOP LEVEL SHEET.
4. CPU SHEET: /INTGNT MOVED FROM PIN 31 TO PIN 31 ON HD-6120 PER DATASHEET. DWAGNT MOVED FROM PIN 31 TO PIN 31 ON HD-6120 PER DATASHEET.
5. CPU SHEET: CHANGED TP1 TO J17 WITH A CONNECTION TO GROUND TO ALLOW AN OFF-BOARD RESET SWITCH TO BE USED.
6. MEMORY SHEET: CHANGED SRAM CHIPS FROM QTY. 3 4-BIT WIDTH CHIPS TO QTY. 2 8-BIT WIDTH CHIPS.
7. MEMORY SHEET: ADDED J15 TO ALLOW FOR 27C256 EPROMS OR 28C256 EEPROMS TO BE USED. WITH CORRESPONDING UPDATES TO SOCKET PIN ASSIGNMENTS.
8. IDE SHEET: ADDED F2, J16 & C22 TO ALLOW POWER TO BE SUPPLIED TO CF -> IDE ADAPTERS.

Licensed under the GNU Free Documentation License, Version 1.1
 Portions (c) 2001–2001 by Spare Time Gizmos, www.sparetimegizmos.com
 RBC Edition updates/layout (c) 2016 Andrew Bingham
RetroBrew Computers, www.retrobrewcomputers.org

Sheet: /
 File: SBC6120-RBC.sch

Title: SBC6120-RBC Edition

Size: A4 | Date: 2016-10-08

KiCad E.D.A. kicad 4.0.4+e1-63084ubuntu14.04.1-stable

Rev: 1.10

Id: 1/6

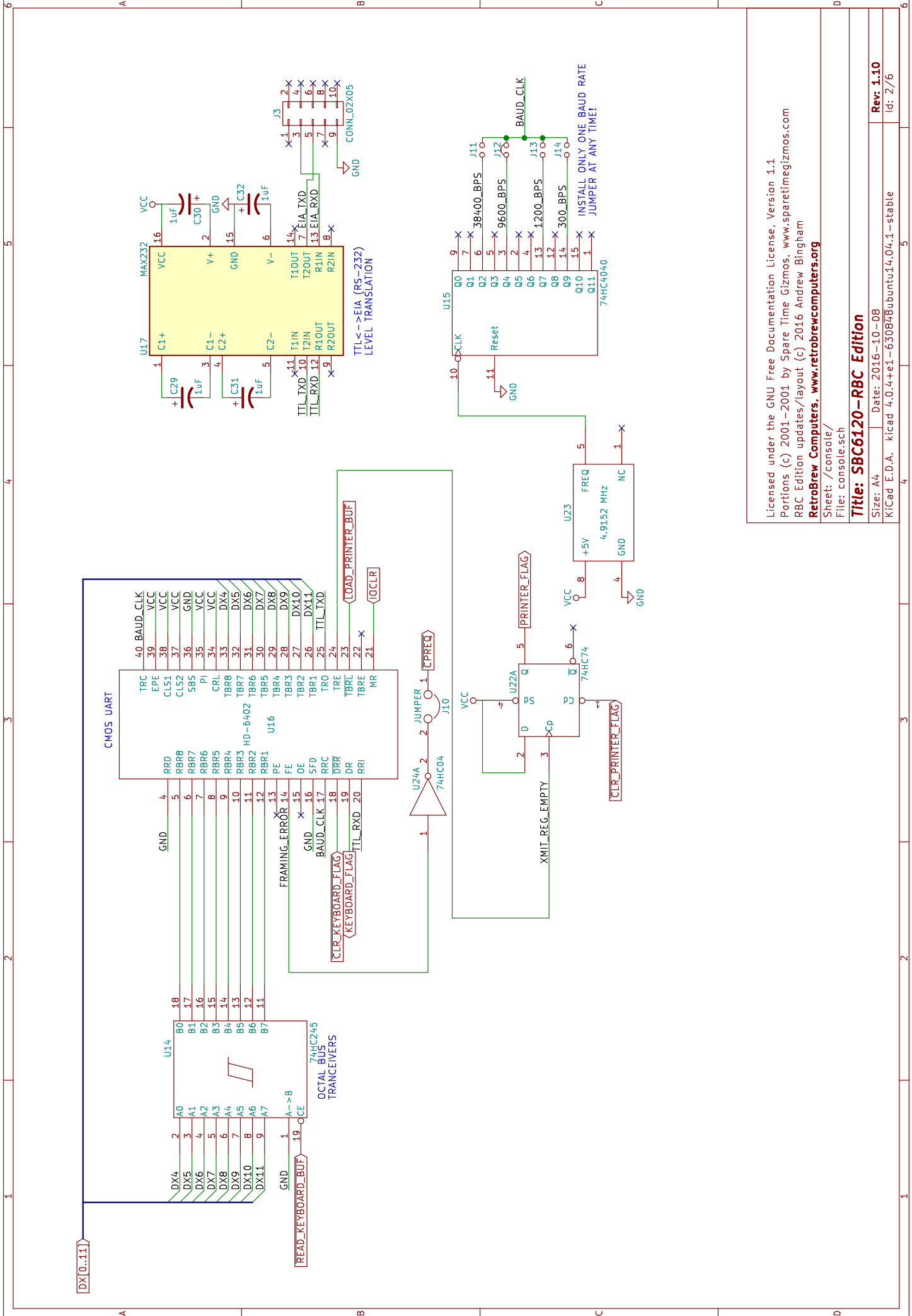

Licensed under the GNU Free Documentation License, Version 1.1
 Portions (c) 2001–2001 by Spare Time Gizmos, www.sparetimegizmos.com
 RBC Edition updates/layout (c) 2016 Andrew Bingham
RetroBrew Computers, www.retrobrewcomputers.org
 Sheet: /console/
 File: console.sch

Title: SBC6120-RBC Edition
 Size: A4 | Date: 2016-10-08
 KiCad E.D.A. kicad 4.0.4+e1-630848ubuntu14.04.1-stable
 Id: 2/76

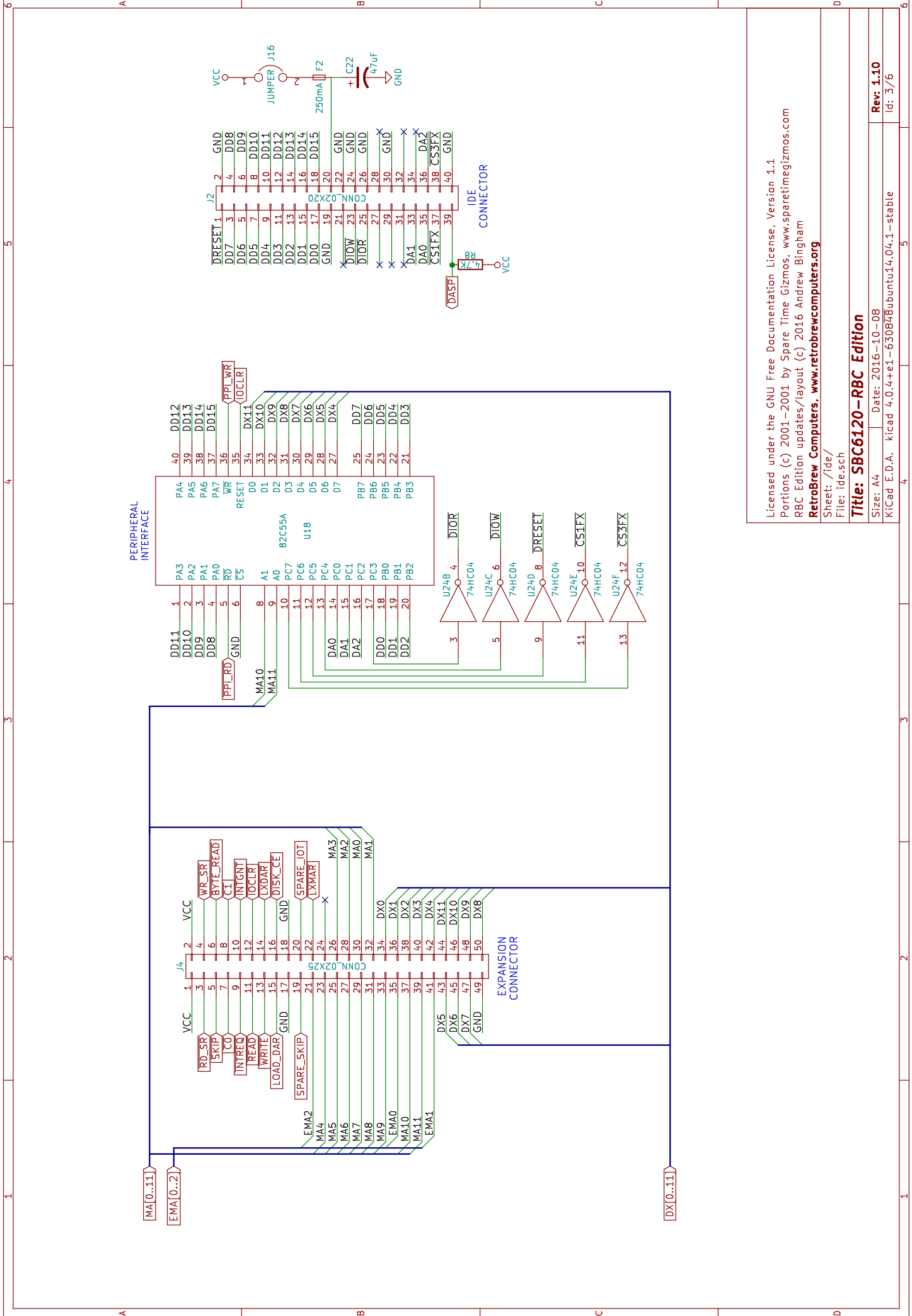

Licensed under the GNU Free Documentation License, Version 1.1
 Portions (c) 2001–2001 by Spare Time Gizmos, www.sparetimegizmos.com
 RBC Edition updates/layout (c) 2016 Andrew Bingham
RetroBrew Computers, www.retrobrewcomputers.org
 Sheet: /Ide/
 File: ide.sch

Title: SBC6120–RBC Edition
 Size: A4 | Date: 2016–10–08
 KiCad E.D.A. kicad 4.0.4+e1–630848ubuntu14.04.1–stable
 Id: 3/6
 Rev: 1.10

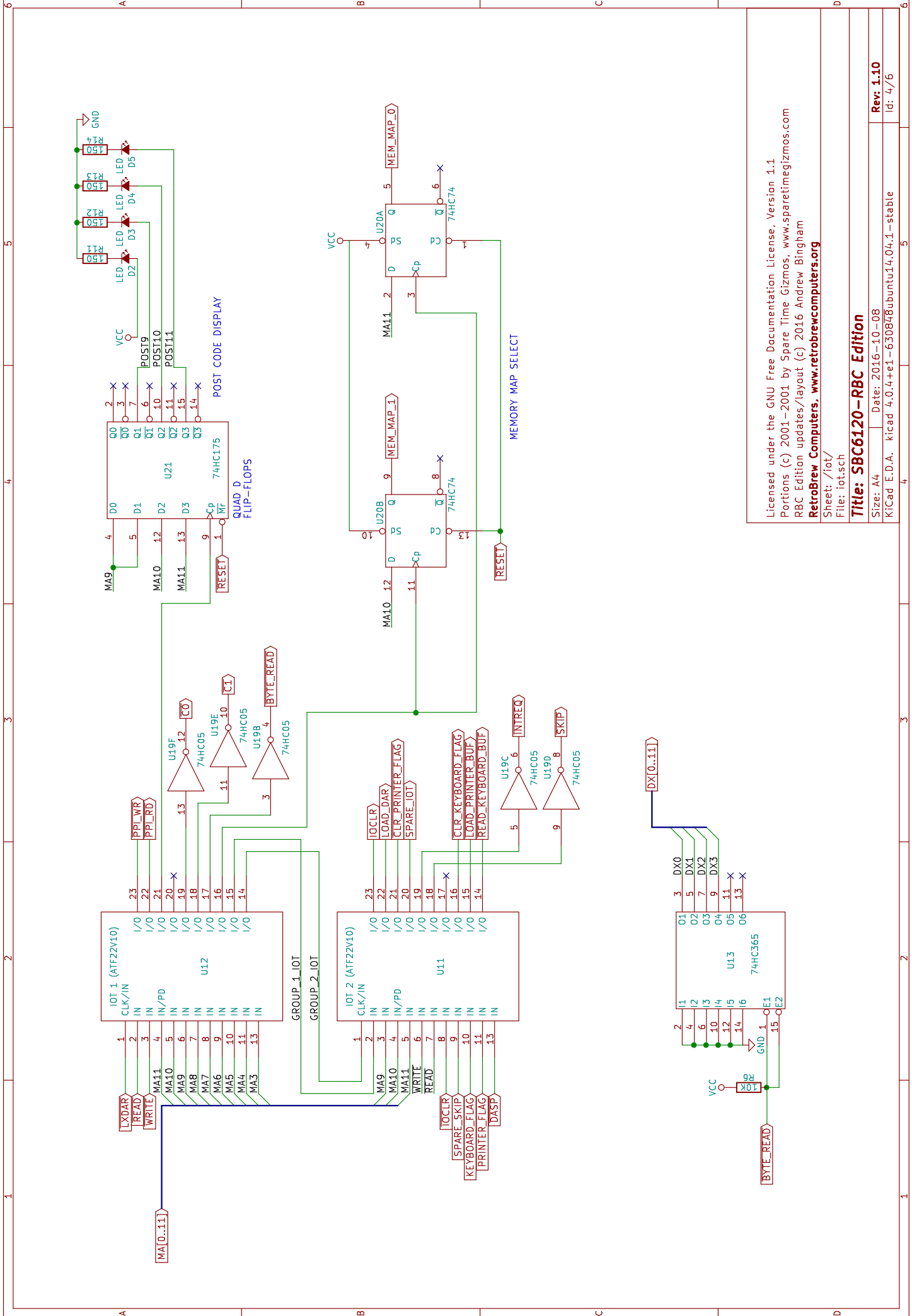

Licensed under the GNU Free Documentation License, Version 1.1
 Portions (c) 2001–2001 by Spare Time Gizmos, www.sparetimegizmos.com
 RBC Edition updates/layout (c) 2016 Andrew Bingham
RetroBrew Computers, www.retrobrewcomputers.org
 Sheet: /iot/
 File: iot.sch

Title: SBC6120-RBC Edition

Size: A4 | Date: 2016-10-08 | Rev: 1.10
 KiCad E.D.A. kicad 4.0.4+e1-630848ubuntu14.04.1-stable | Id: 4/6

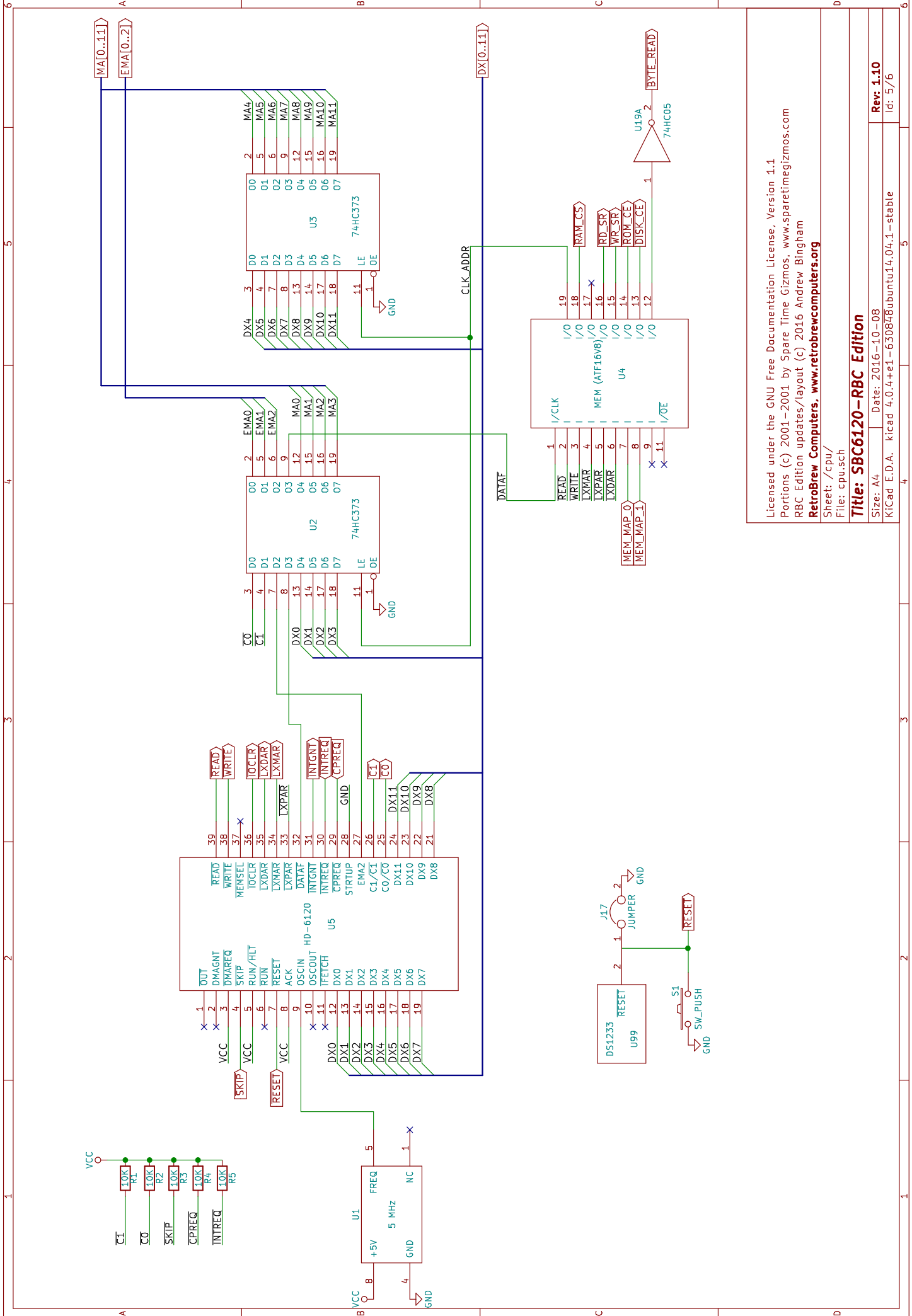

Licensed under the GNU Free Documentation License, Version 1.1
 Portions (c) 2001–2001 by Spare Time Gizmos, www.sparetimegizmos.com
 RBC Edition updates/layout (c) 2016 Andrew Bingham
RetroBrew Computers, www.retrobrewcomputers.org
 Sheet: /cpu/
 File: cpu.sch

Title: SBC6120-RBC Edition

Size: A4 | Date: 2016-10-08 | **Rev. 1.10**
 KiCad E.D.A. kicad 4.0.4+e1-630848ubuntu14.04.1-stable | Id: 5/76

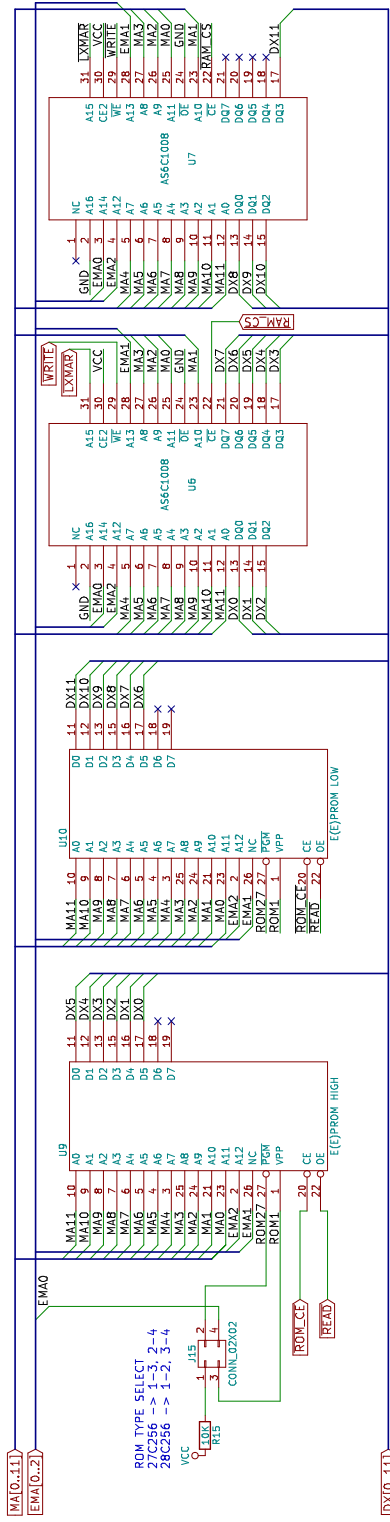

Licensed under the GNU Free Documentation License, Version 1.1
 Portions (c) 2001-2001 by Spare Time Gizmos, www.sparetimegizmos.com
 RBC Edition updates/layout (c) 2016 Andrew Bingham
RetroBrew Computers, www.retrobrewcomputers.org
 Sheet: /memory/
 File: memory.sch
Title: SBC6120-RBC Edition
 Size: A3 Date: 2016-10-08 Rev: 1.10
 KICad E.D.A., Kicad 4.0.4+e1-6308a8abuntuf4.04.1-stable Id: 6/6